

Prof.	L	B	C
270	265	96	267
300	295	128	297
350	345	128	347
400	395	192	397
450	445	224	447
500	495	224	497

83 mm | Drawer
Cassetto
Cajón
Tiroir
Gaveta

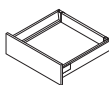

141 mm | Drawer
Cassetto
Cajón
Tiroir
Gaveta

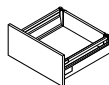

204 mm | Drawer
Cassetto
Cajón
Tiroir
Gaveta

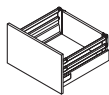

(*)= outer drawer / cassetto esterno/ cajón exterior/ tiroir extérieur / gaveta exterior

(**)= inner drawer / cassetto interno / cajón interior / tiroir intérieur / gaveta interior

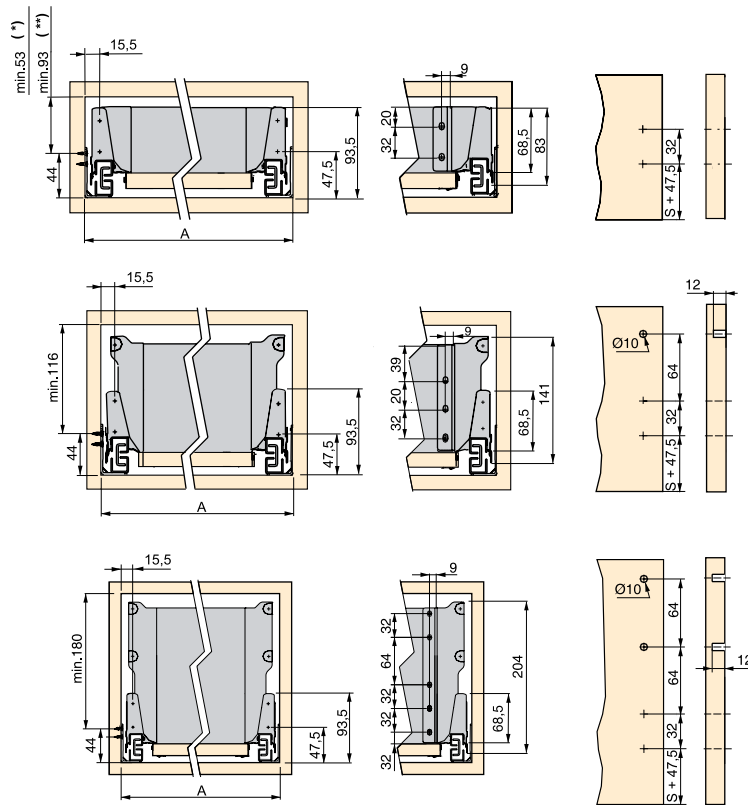

S = Overlay / Sormonto / Solape / Recouvrement / Sobreposição da ilharga

OPTION
OPZIONE
OPCIÓN
OPTION
OPÇÃO

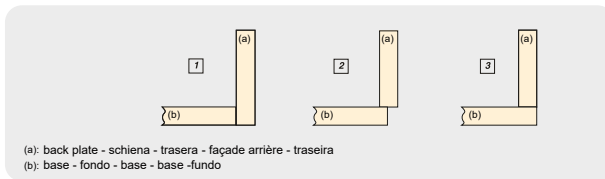

BOTTOM LENGHT - LUNGHEZZA FONDO - LONGITUD FONDO - LONGUEUR DU FOND DE TIROIR - COMPRIMENTO FUNDO

Option - Opzione - Opción - Option - Opção		
1	2(*)	3(**)
Prof - 24	Prof - 20	Prof - 4

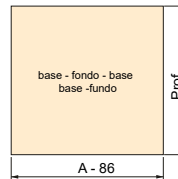

(*) Option to assembly metal back panel.
Opzione per montaggio de schiena metallica.
Opción para montaje de trasera metálica.
Option pour montage façade arrière métallique.
Opção para montagem de traseira de metal.

(**) Option 3 / Opzione 3 / Opción 3 / Option 3 / Opção 3:



16mm = Board thickness
Spessore pannello
Espesor tablero
Panneau
Espessura do painel

DRAWER PANEL HEIGHT - ALTEZZA SCHIENA - ALTURA TRASERA - HAUTEUR FAÇADE ARRIÈRE - ALTURA TRASEIRA

		Option - Opzione - Opción - Option - Opção	
		1	2 - 3
Drawer Cassetto Cajón Tiroir Gaveta	83	84	68
	141	135	119
	204	199	183

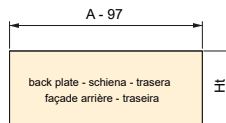

INNER DRAWER
CASSETTO INTERNO
CAJÓN INTERIOR
TIROIR INTÉRIEUR
GAVETA INTERIOR

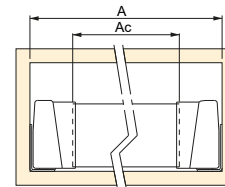
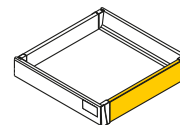

$$Ac = A - 98$$

FRONTAL RAILING FOR INNER DRAWER
ASTINA FRONTALE PER CASSETTO INTERNO
FRONTAL RAILING FOR INNER DRAWER
BARANDILLA FRONTAL PARA CAJÓN INTERIOR
REHAUSSE FRONTALE POUR TIROIR INTÉRIEUR
CERCO FRONTAL PARA GAVETA INTERIOR

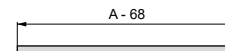
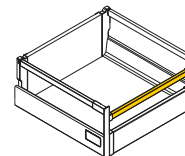

A = Inner module / Interno modulo / Interior módulo / Interieur caisson / Interior de módulo

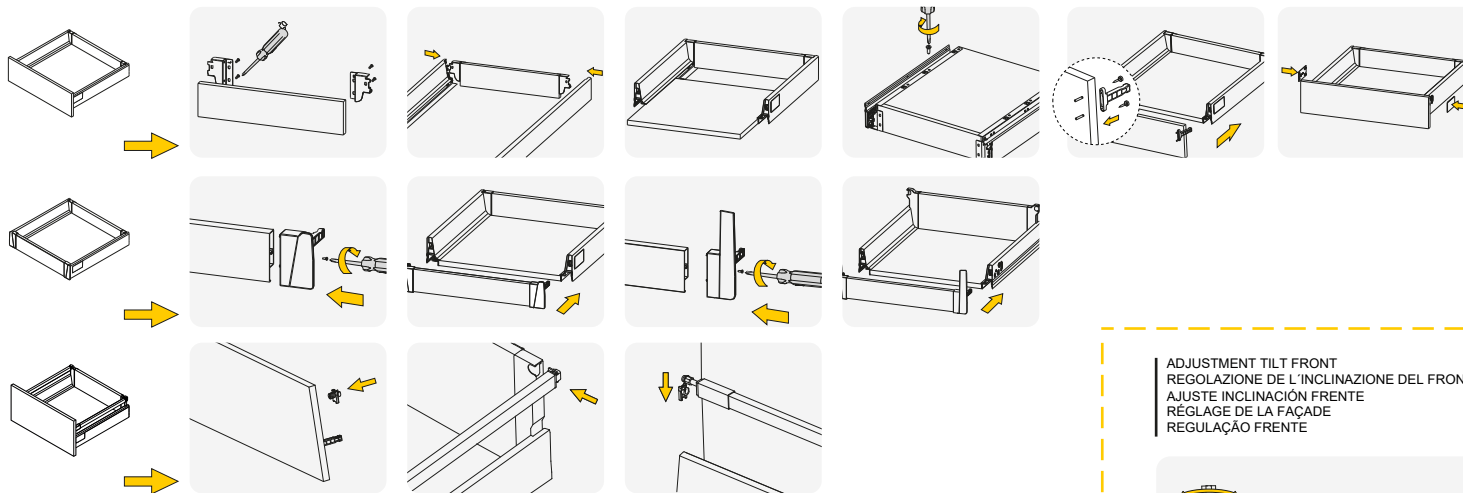

ADJUSTMENT
REGOLAZIONE
REGULACION
RÉGLAGE
REGULAÇÃO

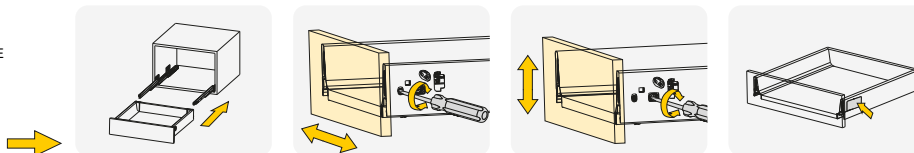

DISMOUNTING
SMONTAGGIO
DESMONTAJE
DÉMONTAGE
DESMONTAGEM

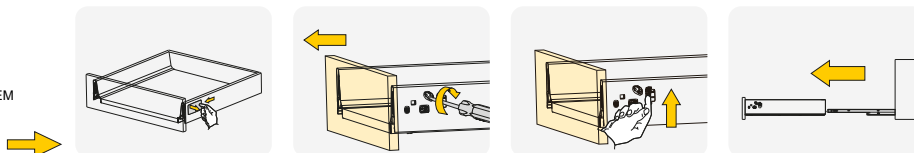

ADJUSTMENT TILT FRONT
REGOLAZIONE DE L'INCLINAZIONE DEL FRONTALE
AJUSTE INCLINACIÓN FRENTE
RÉGLAGE DE LA FAÇADE
REGULAÇÃO FRENTE

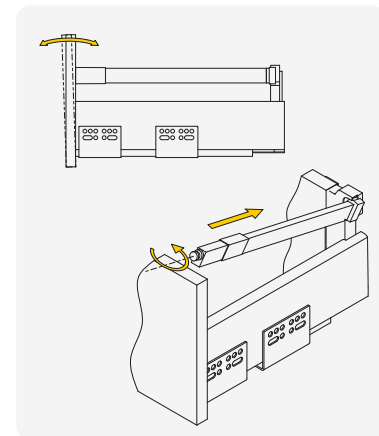

INNER DRAWER - CASSETTO INTERNO - CAJÓN INTERIOR - TIROIR INTÉRIEUR - GAVETA INTERIOR

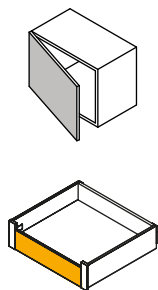

Aluminium / Alluminio
Aluminio / Aluminium
Alumínio / Aluminium

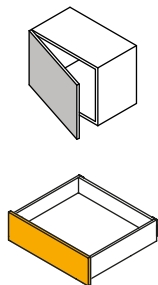
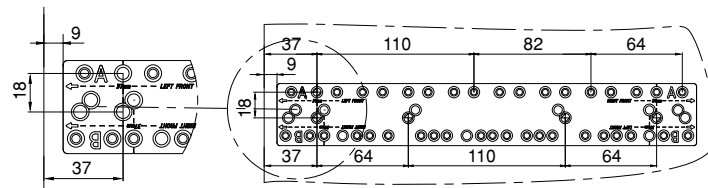
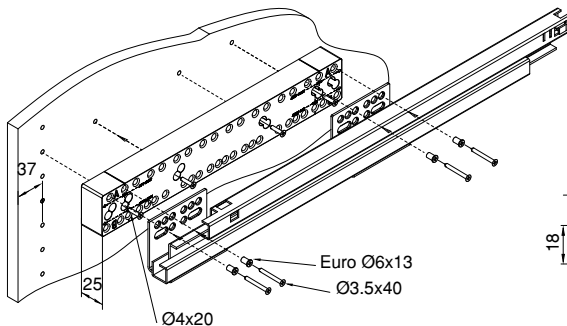

Wood / Legno
Madera / Bois
Madeira / Drewno

